



INSTRUCTIONS MANUAL

Digital advertising display

DKS-LED43, Android 11
DKST-LED43, Android 11



Please read this manual before using the product and follow the instructions it contains!

GENERAL

Foreword	3
Safety Instructions	3
Technical data	4
Overview of the main components	5
Assembly	5
Operating instructions	6

MAINTENANCE

Regular inspection	8
Troubleshooting	9
Service & contact	9
UKCA Declaration of Conformity	10

FOREWORD

Congratulations on the purchase of your new digital advertising display. This unit has been manufactured from high quality materials specifically designed for long-lasting and reliable use. For your own safety and to ensure correct operation of the digital advertising display, be sure to read and follow these operating instructions before using it. Keep these operating instructions.

Check the unit for transport damage. Damaged advertising displays must not be put into use. The digital advertising display is used to display advertising in a customer-effective manner. Improper handling may result in injury or damage to the unit.

Any liability for damage resulting from improper use of the unit or disregard of the specifications and rules of conduct in this operating manual is excluded. The operator is responsible for ensuring correct use by trained and authorised personnel.

The german operating instructions are the original operating instructions, while editions in other languages are translations. Technical changes are reserved.

SAFETY INSTRUCTIONS

- Do not use or store the unit in a humid environment. Make sure that the ambient temperature is between 0 - 50 °C.
- The digital advertising display is only suitable for indoor use. Do not use it near water.
- Make sure that the surface is level.
- Switch off and unplug the power supply before cleaning the display. Spray cleaning solution on a microfibre cloth to clean the unit. Never spray cleaning solution directly on the unit.
- Do not block the ventilation slots or place the unit near a heat source or other equipment that may affect ventilation.
- Do not carry out repair work on your own. In case of problems, contact our customer service.
- Use the unit with a stable power supply. Use only the power cord supplied with the unit.
- Overloaded mains sockets and extension cords are a source of danger. This also applies to damaged mains cables and plugs. This may result in a risk of electric shock or cable fire.
- Do not drop any objects on the unit.
- Do not subject the unit to shocks.
- Disconnect the unit from the power supply when not in use. Never leave the display switched on when you leave the premises.
- Never touch the power cord during a thunderstorm. There is a risk of electric shock.
- Modifications and alterations to the unit not approved by the manufacturer will void the warranty.

TECHNICAL DATA

GENERAL

Type	Unit	DKS-LED43	DKST-LED43
Colour		Black / White	
Dimensions (W x D x H)	mm	610 x 450 x 1810	610 x 450 x 1787
Weight	kg	34	36
Application area		Indoors	
Power consumption (on)	W	≤ 150	
Power consumption (standby)	W	≤ 3	
Response time	ms	5	
Operating time		24 / 7	
Operating system		Android 11	
Random access memory (RAM)	GB	2	
Flash memory (ROM)	GB	16	
Loudspeaker		2 x 10 W Stereo	
Connections and interfaces		USB / RJ-45 / WIFI / Bluetooth / HDMI (IN+OUT)	
Operation		Rockchip 3399	
Processor (CPU)		Remote control	Touch + Remote control

DISPLAY

Type	Unit	DKS-LED43	DKST-LED43
Display		Patented LED module + constant current components	
Material		ESD glass	
Screen diagonal	"	43	
Screen dimensions (W x H)	mm	527 x 939	
Format		9:16	
Resolution	px	1080 x 1920 (Full HD)	
Brightness	cd/m ²	350	300
Contrast		3000:1	1200:1
Colours	Mio.	6.7	
Touchscreen		No	Infrared

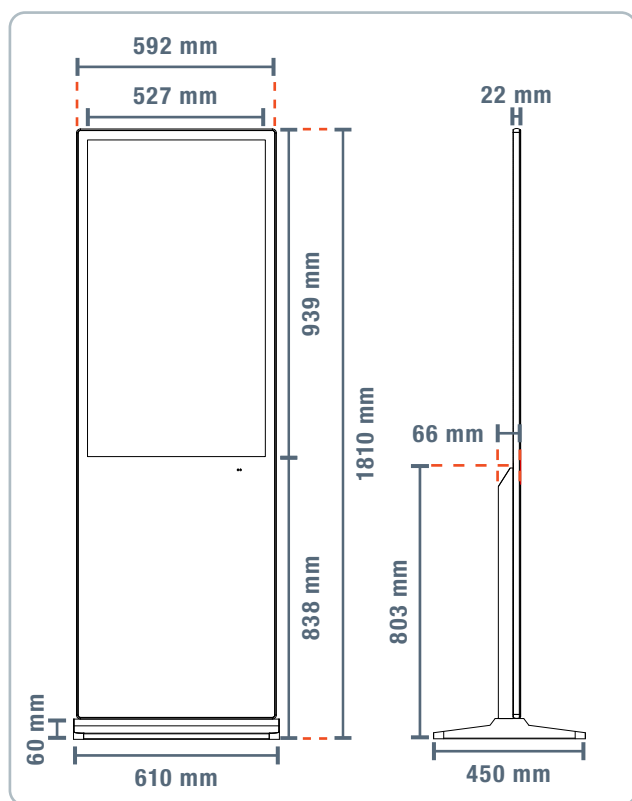

DKS-LED43

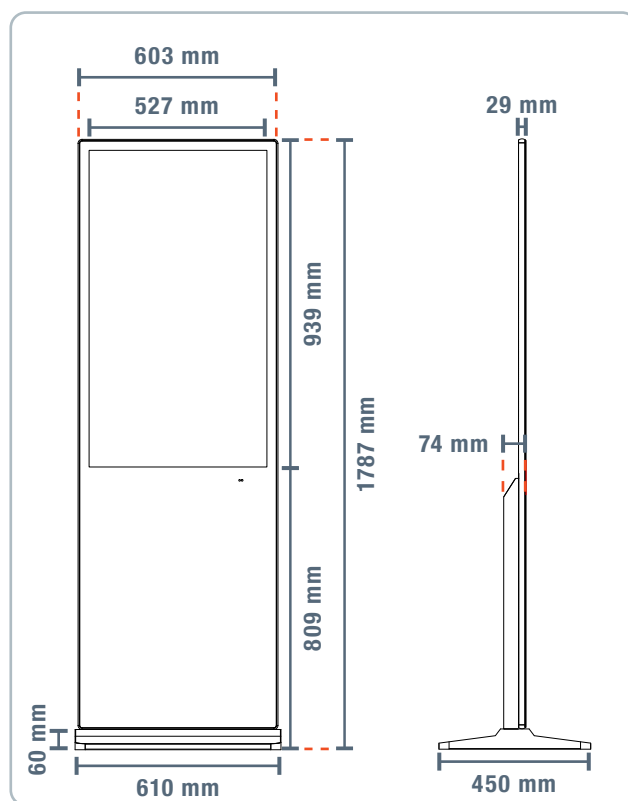

DKST-LED43

OVERVIEW OF THE MAIN COMPONENTS

No.	Name
1	Key
2	HDMI out
3	HDMI in
4	USB
5	RJ45 / LAN
6	ON / OFF
7	Radio antenna
8	Mains cable connection
9	Nameplate
10	ON / OFF

No.	Name
11	Mouse use
12	Forward / rewind
13	Title forward / Title back
14	Play / Pause
15	Stop
16	Volume up / down
17	Sound off
18	Home
19	Control pad
20	Menu

No.	Name
21	Back
22	Digit keys
23	Delete
24	LCD display
25	Power cable
26	Base

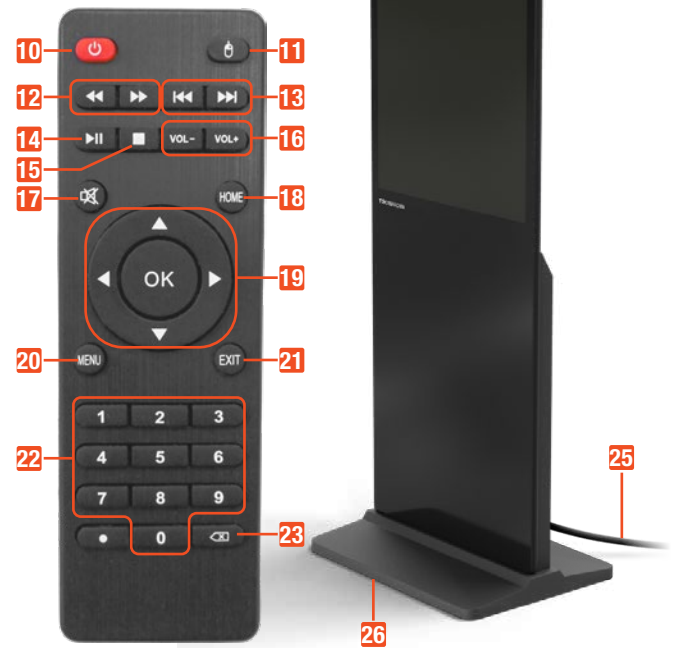
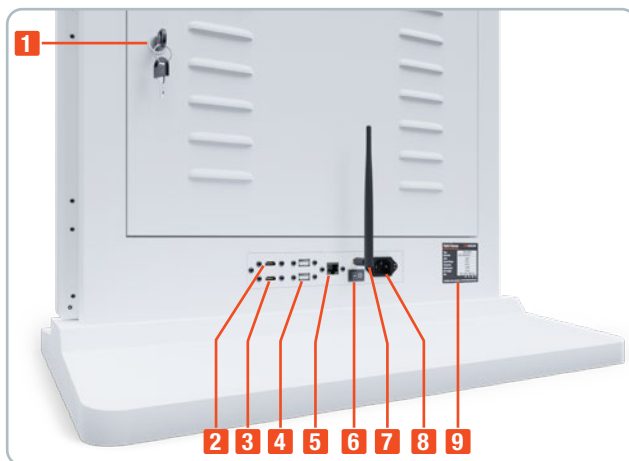

ASSEMBLY



Attach the base with the 6 screws included in the delivery.

Mount the display carefully to avoid scratches.

For easy transport there are two handles on the back of the advertising display.

OPERATING INSTRUCTIONS

1. Make sure that the power cable is plugged in correctly.
2. Now switch on the unit by flipping the ON / OFF toggle switch (6) on the back of the unit.
3. As soon as you switch on the unit, the Android operating system starts and the start screen opens.
4. Select the desired app using touch, with the remote control or a mouse.
5. Use the options menu at the bottom centre of the screen to reach the app overview. All installed apps are listed here. Select the desired app. In the settings, the penultimate tab is "Settings". Here you can adjust all relevant settings, such as time, language and background image.

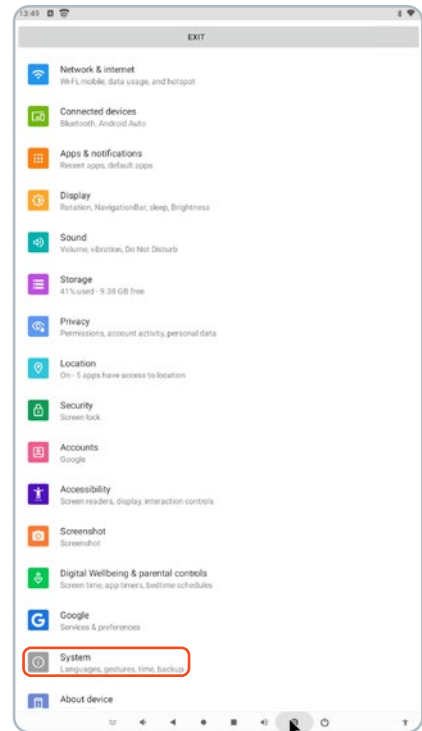
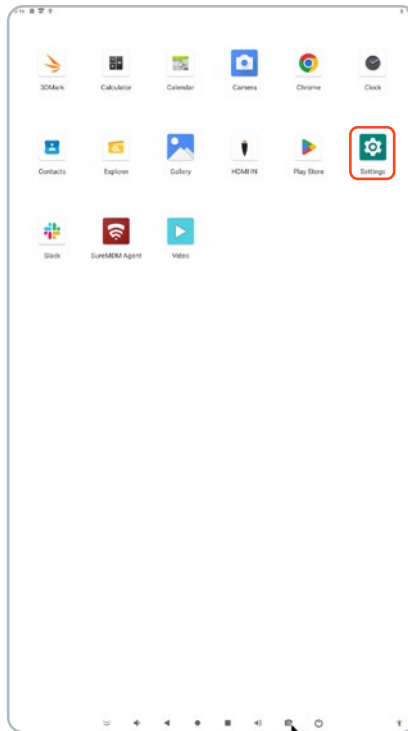
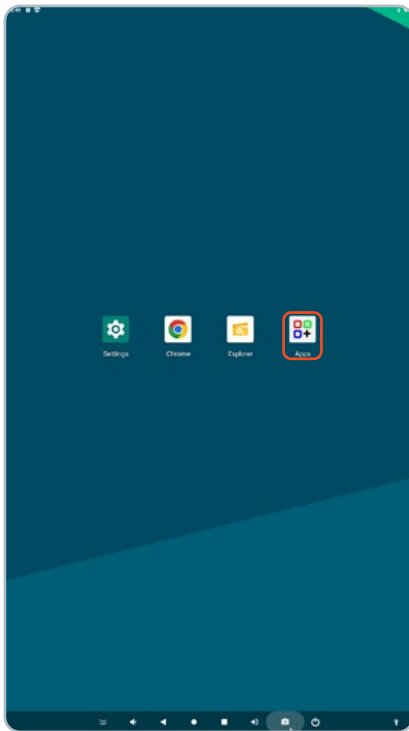

CHANGING THE LANGUAGE

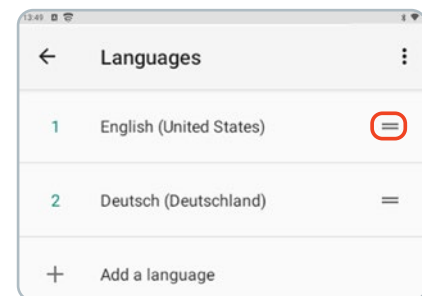
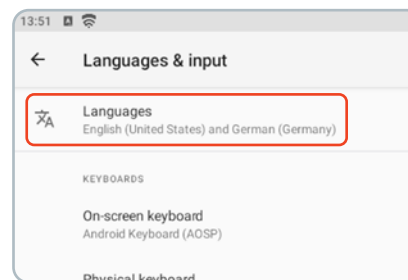
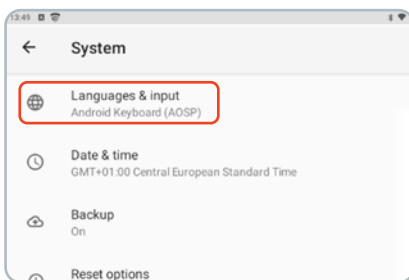

1. Open the "System" tab.
2. Go to "Languages & Input".
3. Go to "Languages".
4. Look for new languages under the tab "Add a language".
5. Move the desired language to the top using the two horizontal lines.

CONNECT TO THE INTERNET

To connect the advertising display to the internet go to the submenu "Network & internet" and enter the access data of your router or use a LAN cable.

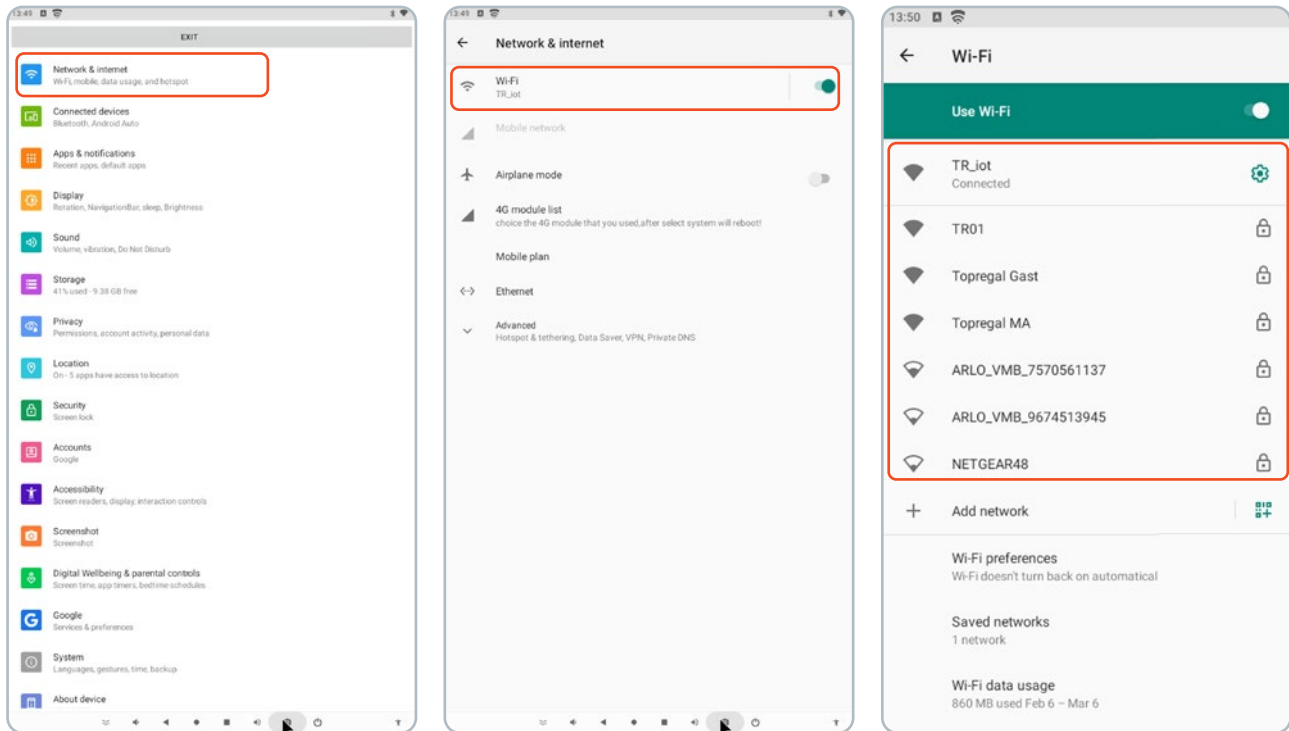

SETTING THE DISPLAY

If you want to change the screen display permanently go to the menu item "Display". Here you can set display options.

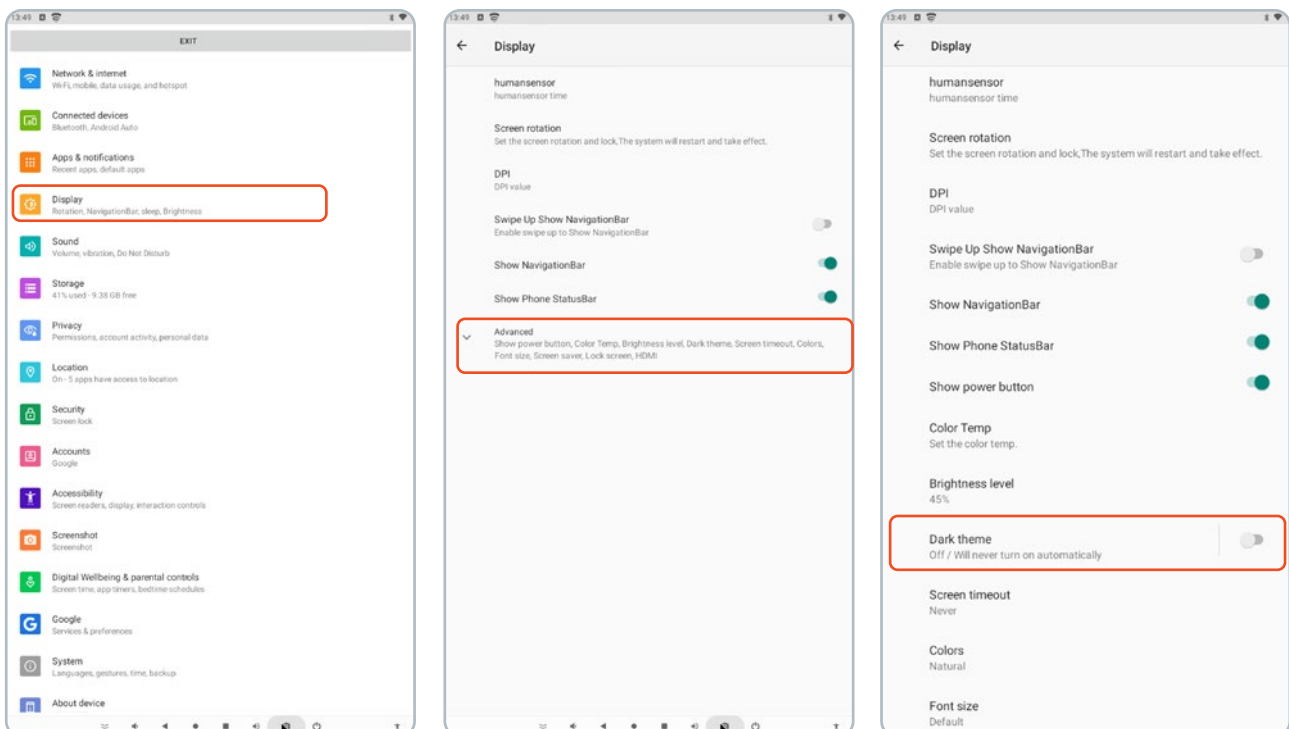

1. You can quickly activate and deactivate functions such as WIFI via the "Status bar" at the top of the screen.
2. You can also see your notifications here, such as received e-mails.
3. The "Navigation bar" at the bottom of the screen gives you the following options:

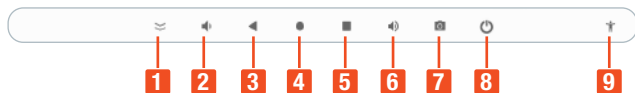

No.	Name
1	Hide bar
2	Volume down
3	Go back to previous page
4	Home screen
5	Overview of all open programmes / app selection
6	Volume up
7	Take screenshot
8	Turn off
9	Assistance

SETTING THE SOUND

You can adjust the volume using the remote control and directly via the "Navigation bar" on the display. In the menu item "Sound", you can also set the applications for which the advertising display plays sounds.

The advertising display supports the following formats:

Medium	Formats
Video	MPEG-1, MPEG-2, MPEG4, H.264, WMV
Audio	MP3, DTS, AAC, WMA
Image	BMP, JPG, JPEG, PNG, GIF

You can download further apps via the pre-installed Play Store. The digital advertising display is delivered with predefined apps.



If you want to display images and videos on the digital advertising display, make sure that they are provided in the correct format (9:16) or with the resolution 1080 x 1920.

CONNECTIONS

RJ45: To access the network if WiFi is not available or a LAN connection is preferred.

USB: External USB inputs. For quick and easy transfer of images and videos to the unit.

HDMI IN: For reproducing e.g. computer content on the advertising display.

HDMI OUT: For reproducing the contents of the advertising display on external sources, such as displays.

REGULAR INSPECTION

Carry out regular visual inspections. Pay particular attention to the display and the power cable.

Clean the display regularly. Spray cleaning solution on a microfibre cloth to clean the unit. Never spray cleaning solution directly onto the unit. Regularly check the ventilation slots at the back of the advertising display.

TROUBLESHOOTING

Problem	Cause	Solution
No picture is displayed and no sound is played back	The mains plug is not plugged in	Plug in the mains plug
	The ON / OFF toggle switch on the back of the unit has not been flipped	Flip the switch
	The sound is set to silent	Increase the volume
The remote control does not work	The distance between the advertising display and the remote control is too far	Reduce the distance between the advertising display and the remote control
	The batteries are flat	Replace the batteries (2 x AAA)
	The remote control is held incorrectly	Aim the remote control directly at the centre of the advertising display
The advertising display crashes	Unstable internet connection	Ensure a stable internet connection
	Roaming activated	Deactivate roaming
Some colours are not displayed correctly	Cables at the back of the advertising display have slipped out	Open the control box at the back and check the cable connections

SERVICE & CONTACT

Contact our product experts and find help and solutions for your product. Here you will find all contact information listed by country and language: www.topregal.co.uk/en/service

Responsible for the content:
 TOPREGAL GmbH
 Industriestrasse 3
 70794 Filderstadt
 GERMANY
www.topregal.com

UKCA Declaration of Conformity

The manufacturer / distributor

TOPREGAL UK Ltd.
Carlton Drive Crumlin,
Gwent NP11 4EA

hereby declares that the following product

Product designation:

TecMaschin
Digital advertising display

Type:

DKS-LED43
DKST-LED43

Serial number:

DKS-LED43-1000000000 - DKS-LED43-9999999999
DKST-LED43-1000000000 - DKST-LED43-9999999999

that the equipment is in conformity with the following relevant UK legislations and applied standards:

2014/53/EU

EN IEC 62368-1
EN IEC 62311
EN 301489-1
EN 301489-17
EN 300328

Name and address of the person who is authorized, compile the technical documentation:

TOPREGAL UK Ltd.
Carlton Drive Crumlin
Gwent NP11 4EA



Place: Crumlin UK
Date: 02.05.2022

Juergen Effner
Chief Executive Officer

TECMASCHIN